

KYOlighT

  
**MARTEX**

# KYOligh

design mario mazzer

pag 03

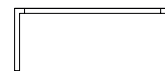

pag 09



pag 15

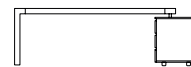

pag 21



pag 26



## Kyo Light

The architectural sign of KYO by Martex has become in recent years an icon of office furniture's design. In the executive segment, KYO, with its unique style, traces the way that clearly defines the meaning of elegance. With KYOlight, the elegant sign of KYO has been translated to a broader market. This happened thanks to the use of new materials and innovative technology that have allowed us to develop a product full of personality. KYOlight has the ability to furnish quality executive areas as well as operational area, or offer a professional solution to meeting rooms.

Il segno architettonico di KYO by Martex è diventato, in questi anni, un'icona nel design per l'arredo d'ufficio. Nel segmento presidenziale e direzionale KYO ha tracciato, con il suo stile inconfondibile, la strada che definisce in maniera chiara il significato di eleganza. Con KYOlight si è traslato il segno elegante di KYO ad un mercato più ampio. Questo è avvenuto grazie all'utilizzo di nuovi materiali e ad una tecnologia innovativa che hanno permesso di sviluppare un prodotto carico di personalità. KYOlight ha la capacità di arredare con qualità un'area presidenziale al pari di un'area operativa, oppure, di risolvere in modo professionale una sala meeting.

Le signe architectural de KYO by Martex est devenu, ces dernières années, une icône dans la conception pour le mobilier de bureau. Dans le segment présidentiel et directionnel KYO a tracé avec son style unique le chemin qui définit clairement le sens de l'élégance. Avec KYOlight on a transféré le signe élégant de KYO à un marché plus large, grâce à l'utilisation de nouveaux matériaux et une technologie innovante, qui nous ont permis de développer un produit plein de personnalité. KYOlight est capable de meubler avec qualité une zone de direction comme une zone opérationnelle, ou bien fournir une solution professionnelle pour la salle de réunion.







Executive desk W. 1880 D. 900 mm with folding legs in melamine elm wood finish, combined with encased tempered glass top lacquered light gray 611.

Scrivania direzionale L. 1880 P. 900 mm con gambe in folding in finitura melaminico olmo, abbinata al piano incassato in vetro temperato laccato grigio chiaro 611.

Bureau directionnel L. 1880 P. 900 mm avec pieds finition mélamine olmo, assortis au plateau en verre trempé laqué grigio chiaro 611.

The collection KYOlight is a project that provides comprehensive solutions to furnish both offices and comfortable meeting rooms of small and medium size. Meeting room is one of the business cards of the company. For this reason it needs to be cozy, elegant, functional and, above all, should reflect company's soul.

La collezione KYOlight è un progetto completo che offre soluzioni per arredare, sia uffici direzionali, sia confortevoli sale riunioni di piccole e medie dimensioni. La sala riunioni è uno dei biglietti da visita dell'azienda, per questo deve essere accogliente, elegante, funzionale e, soprattutto rifletterne l'anima.

La collection KYOlight est un projet qui offre des solutions complètes pour meubler bureaux directionnels comme confortables salles de réunion de petite et moyenne dimension. La salle de réunion est une des cartes de visite de la société, donc elle doit être confortable, élégante, fonctionnelle et, surtout, refléter son âme.







Meeting table solution W. 2400 mm D. 1200 mm with melamine elm wood top finish and legs with 45 ° connection in matt lacquer finish "té verde 407". Legs are also available in high glossy lacquered finish.

Soluzione con tavolo riunione L. 2400 P. 1200 mm piano olmo e gambe con unione a 45° laccate opache finitura té verde 407. Le gambe sono anche disponibili nella versione laccata lucida.

Table de réunion L. 2400 P. 1200 mm avec plateau olmo et pieds unis à 45° laqués mat finition té verde 407. Les pieds sont disponibles aussi en finition laqué brillant.



The new workflows that characterize our society, such as integration, synergy and communication management, have suggested new managers to operate in workplaces that allow the development of relations and connections, abandoning thus, the strict separation of space and functions. However managers, even in this new role, want to keep their role with a recognizable identity that, today, thanks to the new collection KYOlight, it becomes easily accessible to all, thanks to the use of more accessible materials, but high scenic and aesthetic value.

I nuovi flussi di lavoro che contraddistinguono la nostra società, come l'integrazione, la sinergia e la gestione della comunicazione, hanno suggerito ai nuovi manager di operare in luoghi di lavoro che consentono lo sviluppo delle relazioni e della connessione, rinunciando così, alla rigida separazione dello spazio e delle funzioni. I manager, anche in questa nuova veste, vogliono però conservare il proprio ruolo con un'identità riconoscibile che, oggi, grazie alla nuova collezione KYOlight, diventa per tutti facilmente raggiungibile, tramite l'utilizzo di materiali più accessibili, ma di alto valore scenico ed estetico.

Les nouveaux flux de travail qui caractérisent notre société, tels que l'intégration, la synergie et la gestion de la communication, ont suggéré les nouveaux managers à opérer dans des lieux de travail qui permettent le développement des relations et de la connexion, renonçant ainsi, à la stricte séparation de l'espace et des fonctions. Les managers, même dans ce nouveau rôle, veulent cependant garder leur rôle avec une identité reconnaissable qui, grâce à la nouvelle collection KYOlight, devient aujourd'hui facilement accessible à tous, grâce à l'utilisation de matériaux plus accessibles, mais avec une grande valeur esthétique.







KYOligh presents a high content of functionality thanks to a range of containers that complete the collection. In the picture structural service unit W. 1600 D. 550 mm completely equipable for electrification.

KYOligh presenta un elevato contenuto funzionale grazie ad una gamma di contenitori che ne completano la collezione. Nella foto contenitore strutturale L. 1600 P. 550 mm completamente elettrificabile.

KYOligh présente un contenu fonctionnel élevé grâce à une gamme de meubles qui complètent la collection. En photo: meuble structurel L. 1600 P. 550 mm entièrement électrifié.

Essential and original lines: volumes, thicknesses, combination of materials and colors are just some of the elements that distinguish the collection KYOlight. The color combinations available in KYOlight perfectly match the storage and complements collection of Martex. The desk is available with side extension, structural service unit, fixed or mobile and a functional electrification of the workplace.

Linee essenziali ma originali: volumi, spessori importanti, abbinamento di materiali e colori diversi sono solo alcuni degli elementi che contraddistinguono la collezione KYOlight. Le combinazioni cromatiche previste dalla linea KYOlight si abbinano perfettamente ai contenitori e complementi della collezione Martex. La scrivania è disponibile con allungo laterale, con mobili strutturali su ruote o su piedi, e con una funzionale elettrificazione del posto di lavoro.

Des lignes sobres mais originaux: volumes, grand épaisseur, combinaison de matériaux et de plusieurs couleurs sont quelques-uns des éléments qui distinguent la collection KYOlight. Les combinaisons de couleurs disponibles dans la collection KYOlight s'assortissent parfaitement aux meubles et accessoires de la collection Martex. Le bureau est disponible avec rallonge latérale, avec meubles structurels, sur roulettes ou avec pieds et aussi avec une électrification fonctionnelle de la place de travail.





The desktop is available in melamine elm wood finish, nocino, lacquered glass or in faux-leather in 10 different colors.

Il piano della scrivania è disponibile nella finitura olmo, nocino, vetro laccato oppure nella versione ecopelle disponibile in 10 colori diversi.

Le plateau est disponible en finition olmo, nocino, verre laqué ou en version éco-cuir disponible en 10 couleurs différentes.





Round table diameter 1000 mm here shown in nocino top and titanium paint column base; the metal column is also available in 26 Martex lacquered colors.

Tavolo tondo diametro 1000 mm qui rappresentato con piano nocino e piantana titanio; la piantana è disponibile anche laccata nei 26 colori laccati Martex.

Table ronde diamètre 1000 mm représenté ici avec plateau nocino et pied tulipe titanio; le pied tulipe est disponible aussi laqué dans 26 différents couleurs Martex.

CATALOGUES' COMPOSITIONS \_ COMPOSIZIONI A CATALOGO \_ COMPOSITIONS DE CATALOGUE

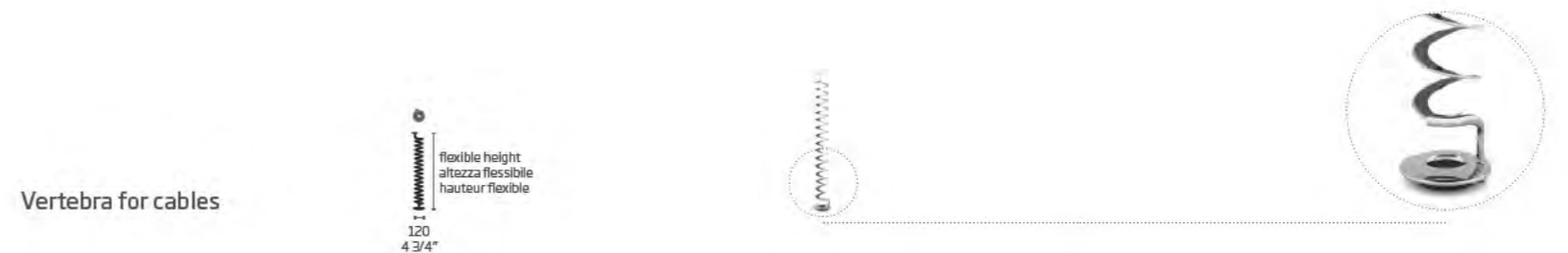
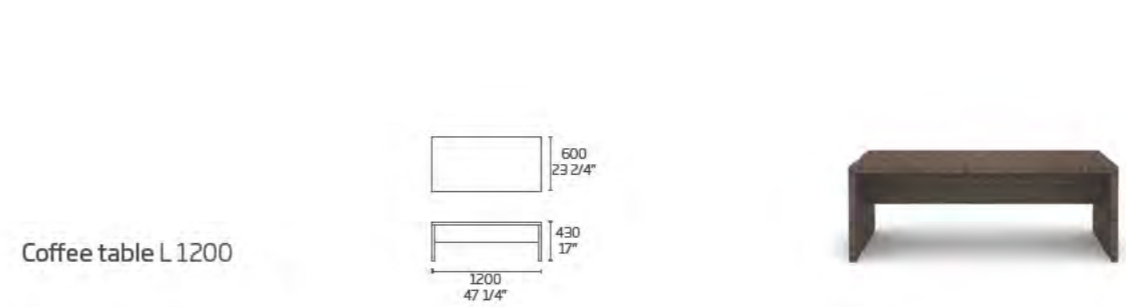
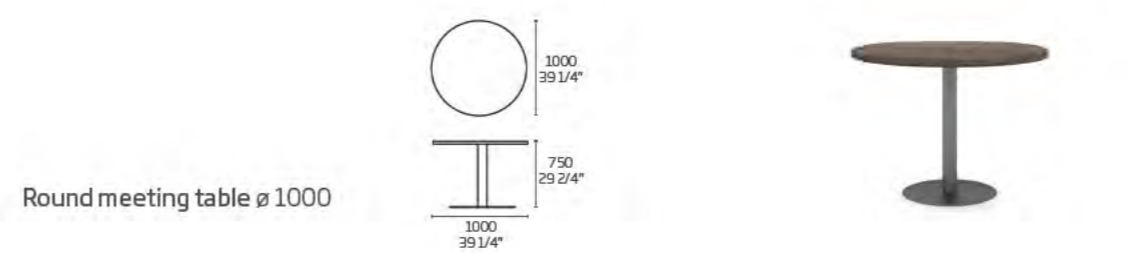



## FINISHINGS \_ FINITURE \_ FINITIONS

### MATT LACQUERED COLOURS / LACCATI OPACHI / LAQUÉ MAT



### GLOSSY LACQUERED / LACCATI LUCIDI / LAQUÉ BRILLANT

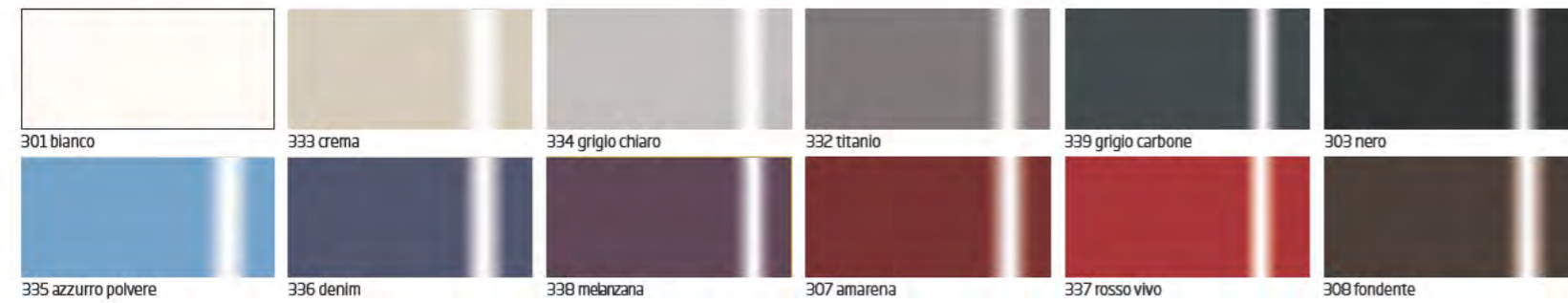

### MELAMINE / MELAMINICO / MELAMINÉ

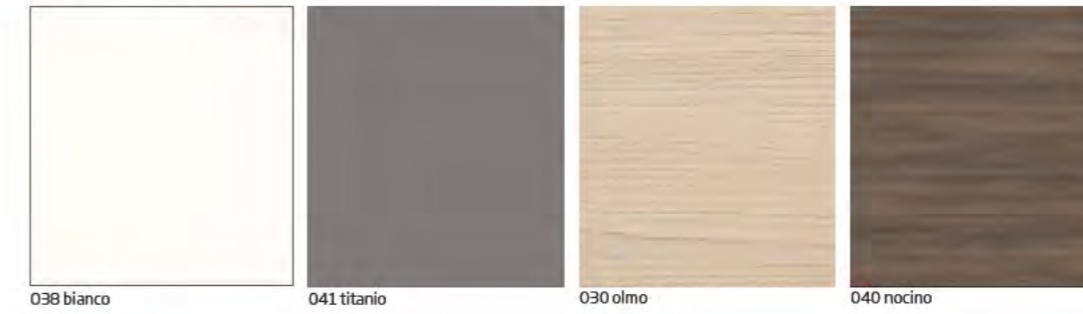

### LACQUERED GLASS / VETRO LACCATO / VERRE LAQUÉ

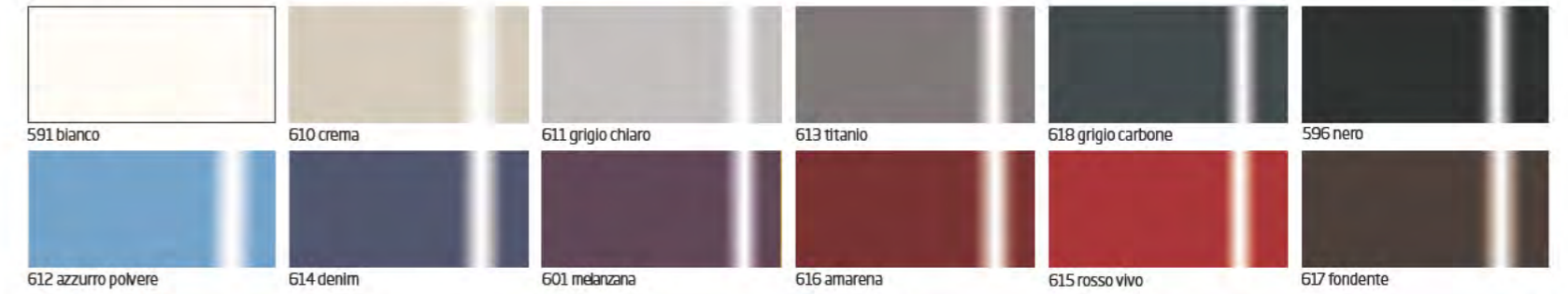

### METAL / METALLO / MÉTAL



### FAUXLEATHER / ECOPELLE / SIMILCUIR

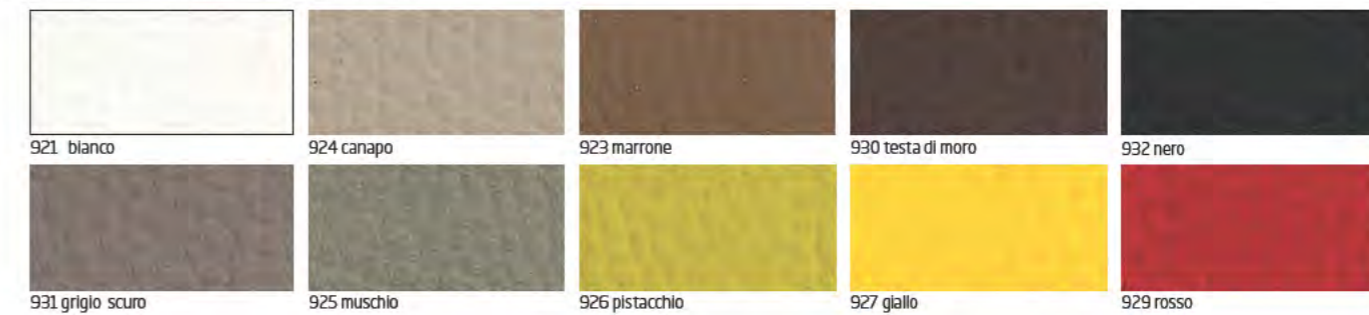

Martex reserves the rights at all time to apply modifications for the functional or qualitative improvement of its products. Texts and drawings present in this brochure have a divulgative purpose: for every technical and dimensional aspect please refer to the company's price lists and their relative updatings. The colour and material samples have an indicative value.

Martex si riserva il diritto di apportare, senza preavviso, ogni modifica mirata al miglioramento funzionale e qualitativo dei propri prodotti. Testi e disegni presenti in questo stampato hanno scopo divulgativo: per ogni aspetto tecnico e dimensionale fare riferimento ai listini aziendali e relativi aggiornamenti. I campioni di colori e materiali hanno valore indicativo.

Martex se réserve le droit d'apporter, sans préavis, toute modification utile à améliorer la fonctionnalité et la qualité de ses produits. Les textes et dessins dans ce document sont pour des fins d'information: pour tous les aspects techniques et de dimensions il faut se référer aux tarifs et relatives mises à jour. Les échantillons de couleurs et de matériaux ont une valeur indicative.

Art direction: Mario Mazzer Architects  
Images: Mario Mazzer Architects  
Print: [www.sincromia.it](http://www.sincromia.it)

1° EDIZIONE GENNAIO 2016

Martex is certified  
UNI EN ISO 9001:2008

Martex  
via Sagré, 19  
Prata di Pordenone (PN) Italy  
tel +39 0434 602310  
fax +39 0434 602319  
[info@martex.it](mailto:info@martex.it)



[martex.it](http://martex.it)